



GREMSY

PIXY U

USER MANUAL

Version 1.0 | October 1, 2019

REVISION HISTORY

REVISION	DATE	DESCRIPTION
1.0	October 1, 2019	User Manual

LEGEND



NOTE

Notes are used to highlight special operating conditions or steps of a procedure.



WARNING

Warnings are used to highlight procedures which, if not strictly observed, may result in personal injury or loss of life.



TIPS

Tips.

CONTENTS

Revision History	2
Legend	2
GETTING STARTED	6
Introduction	7
Features	8
HDMI Hyper Quick Release	
Universal	
Heated & Temperature Controlled IMU	
High Performance Gimbal Controller	
Clean Design - Internal Wiring	
Built for Aerial Work	
Specifications	10
PIXY U I/O Connectors	11
Hyper Quick Release Connectors & Pinouts	
Tilt Connectors & Pinouts	
What's In The Box	15
Hyper Quick Release	16
Mounting Hyper Quick Release	
Connect	
Disconnect	
Powering Up The PIXY U	18
Step 1	
Step 2	
Step 3	
Status LED Indicator	19
Operation Modes	20
PIXY U Has 2 Operation Modes	
PIXY U Supports	
Working Operation	21
Swithing Between Modes	22

INSTALLING SOFTWARE	23
Steps To Connect	24
BALANCING	25
Mounting The Camera	26
Tilt Axis Front-Back Balance	27
Tilt Axis Vertical Balance	28
Roll Axis Balance	29
Pan Axis balance	30
SOFTWARE - TUNING	31
Stiffness Tuning	32
General Method	
Step 01 - Tilt Stiffness	
Step 02 - Roll Stiffness	
Step 03 - Pan Stiffness	
Filter	34
Gyro Filter	
Output Filter	
Gyro Filter	
Expert / Advanced Settings	35
Hold Strength	
Gain	
Default Settings	
Predefined Profiles	37

Follow Mode Settings	38
Speed	
Smooth	
Window	
Tilt Lock	
Rotation Limit	
Up Limit	
Down Limit	
Window	
IMU SENSOR	40
Gyro Calibration	41
Accelerometer Calibration	42
REMOTE CONTROL	43
SBUS/PPM Settings	44
Receiver Connection	
Channel Setting	
JR/SPEKTRUM Settings	46
JR/SPEKTRUM Satellite Receiver Connection	
Channel Setting	
UPGRADING FIRMWARE	47
How To Upgrade	48
TROUBLESHOOTING	49

GETTING STARTED

INTRODUCTION

PIXY U is a universal 3-axis gimbal that can handle a wide variety of cameras, features Hyper quick release with integrated HDMI, a variety of I/O interfaces and ability to start up in 2 seconds.

FEATURES

HDMI HYPER QUICK RELEASE

New mechanical and electrical integration quick release features high-speed connectors allow for HDMI transmission and other I/O interface. A variety of ports on QR allow quickly interface with multiple devices such as 3rd party flight controller, remote control, auxiliary I/O.



UNIVERSAL

Ability to adjust balancing in 3 axis allows PIXY U to mount a wide range of cameras such as FLIR DUO PRO R, WIRIS SECURITY, SONY QX30...



Sony QX30

Blackmagic Micro Cinema Camera

[View More Cameras >>](#)



HEATED & TEMPERATURE CONTROLLED IMU

Heated and temperature controlled IMU sensor allows reliable performance even in extreme weather. Temperature is maintained within 0.2 degrees Celsius accuracy.

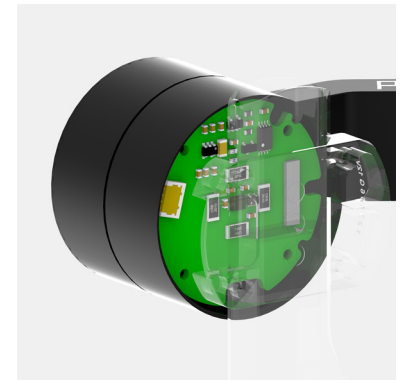

HIGH PERFORMANCE GIMBAL CONTROLLER

Advanced gimbal controller designed and made by GremSy based on a 32 bit high performance ARM microprocessor providing fast response and accurate calculation. Sensor data and motors correction are updated as fast as 2000 times per second to enable incredibly smooth footage.



CLEAN DESIGN - INTERNAL WIRING

No exterior wires, more solid. This clean design helps the PIXY U overcome wind resistance with ease to bring out the best video quality while staying agile.



BUILT FOR AERIAL WORK

Light-weight and small form factor, PIXY U could be mounted to various flying platforms and enable longer flight time.



SPECIFICATIONS

Product Name	Pixy U
System Type	3-Axis Digital Gyro-Stabilized
Weight	1.0 lbs / 465 g
Maximum Payload	1.0 lbs / 465 g
Construction	All Aluminum
Input Voltage UBEC	14 – 52V
Input Voltage Gimbal	12V / 5A
Working Current	Static Current 400mA @12V Dynamic Current 800mA @12V Locked Motor Current Max 3.5A @12V
Connection	USB, CAN, UART, HDMI
OS Platform Supported	Windows / Mac
Single Operator	Follow Mode / LB2
Dual Operator	SBUS / Spektrum / PPM / LB2
Pan Range	+/- 330 degree
Tilt Range	-45 degree / +135 degree
Roll Range	-90 degree / +45 degree

PIXY U I/O CONNECTORS

HYPER QUICK RELEASE CONNECTORS & PINOUTS

- **POWER:** 12V input. Connect the stable 12V output from the provided UBEC to this connector.

The UBEC allows 14V-52V input range and output 12V/5A

Connector type: JST SM02B-SFKH-TF

- **COM1/CAN:** COM1 is a serial protocol (UART) port which is used to interface with a computer via USB. CAN is to interface with DJI Flight controller.

Connector type: JST SM06B-GHS-TB(LF) (SN)

- **COM2/COM3:** COM2/COM3 is serial protocol (UART) port, this port is internally connected to COM2/COM3 port on the gimbal controller. COM2 is to interface with Pixhawk via Mavlink protocol or other modules that use serial protocol (UART). COM3 is reserved for future use.

Connector type: JST SM06B-GHS-TB(LF) (SN)

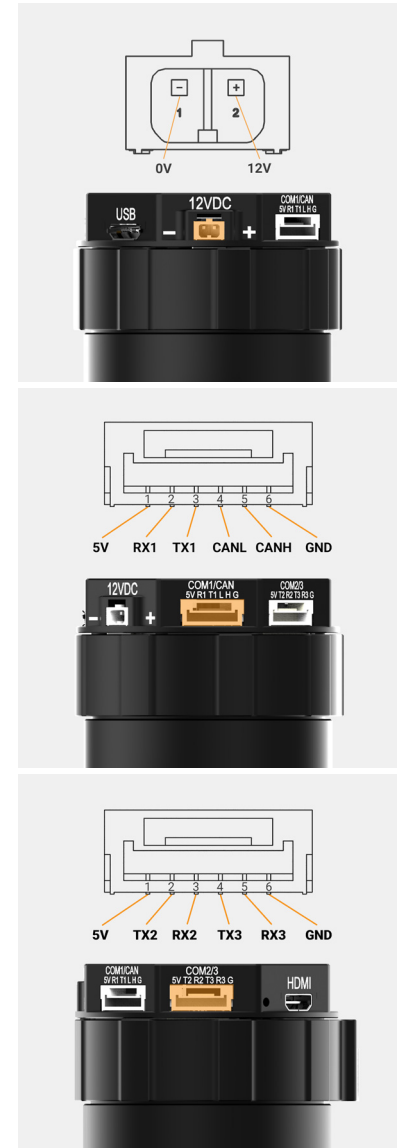

■ **SBUS/PPM:** to interface with SBUS/PPM receiver. This port is internally connected to SBUS/PPM port on the gimbal controller.

Connector type: 3 pin, 2.54mm pitch

■ **JR:** to interface with JR/SPEKTRUM satellite receiver.

Connector type: JST S3B-ZR

■ **AUX:** provide 12V output (1A max) to power camera and accessories and optional signals S1, S2, S3, S4, S5, S6 (0.25A max) for users to connect to other devices such as AV signal or camera trigger, This port is internally connected to AUX port on the tilt axis.



WARNING

Do not apply power to AUX port at pin 7 and 8, doing so may damage the electronics of the gimbal.

Connector type: JST GHR-08V-S



- **USB:** to interface with computer or upgrade firmware.

Connector type: Micro USB type B



- **HDMI:** to output video from the camera

Connector type: HDMI micro



TILT CONNECTORS & PINOUTS

- **AUX:** Provide 12V output (1A max) to power camera and accessories and optional signals S1, S2, S3, S4, S5, S6 (0.25A max) for users to connect to other devices such as AV signal or camera trigger,This port is internally connected to AUX port on the hyper quick release.

Connector type: JST GHR-08V-S



- **HDMI:** This cable allows HDMI video output from the camera to the HDMI Micro connector on the QR.

Connector type: HDMI Micro



WHAT'S IN THE BOX

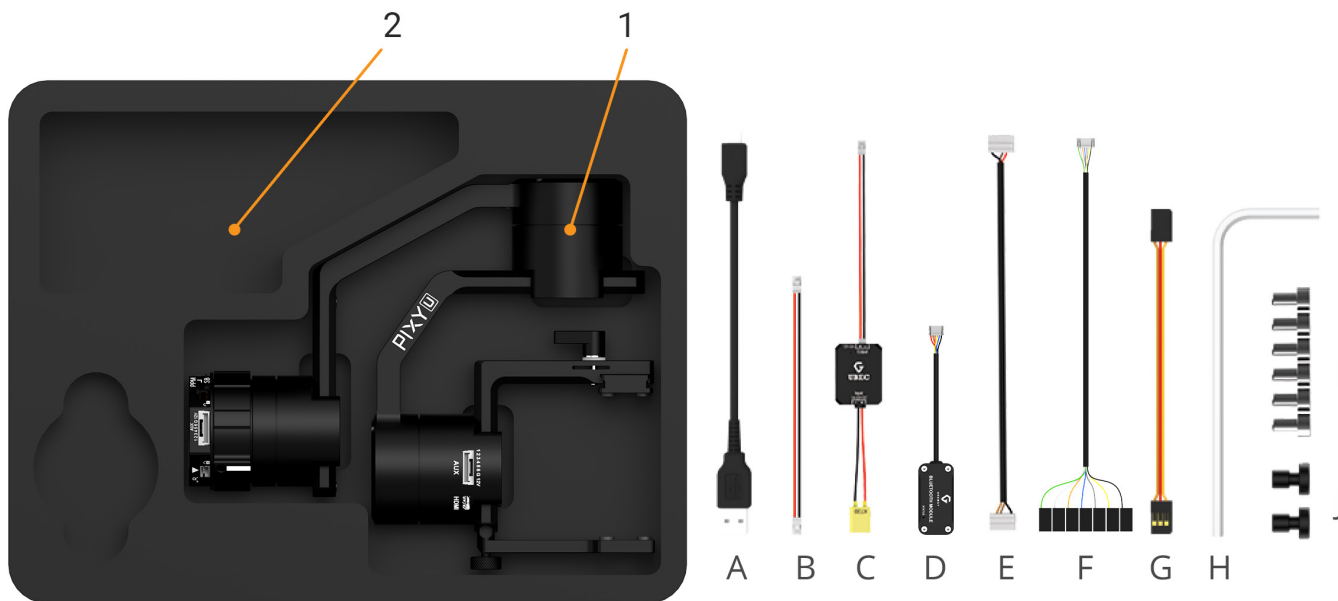

1. PIXY U GIMBAL

2. PIXY U ACCESSORIES

A. Micro USB Cable	x1	F. AUXILIARY Cable 8-pin	x1
B. 12V Power Cable (Backup)	x1	G. SBUS Cable	x1
C. UBEC	x1	H. Allen key	x1
D. Bluetooth Module	x1	I. M2.5x5	x6
E. Cable For Pixhawk	x1	J. Camera Screws	x2

HYPER QUICK RELEASE

MOUNTING HYPER QUICK RELEASE

- Using 4xM2.5 to mount the top part onto the frame or damping isolator.
- Pay attention to the arrow on the hyper quick release which indicates the home position or forward position of the gimbal.



- Connect the UBEC cable to the Hyper QR.

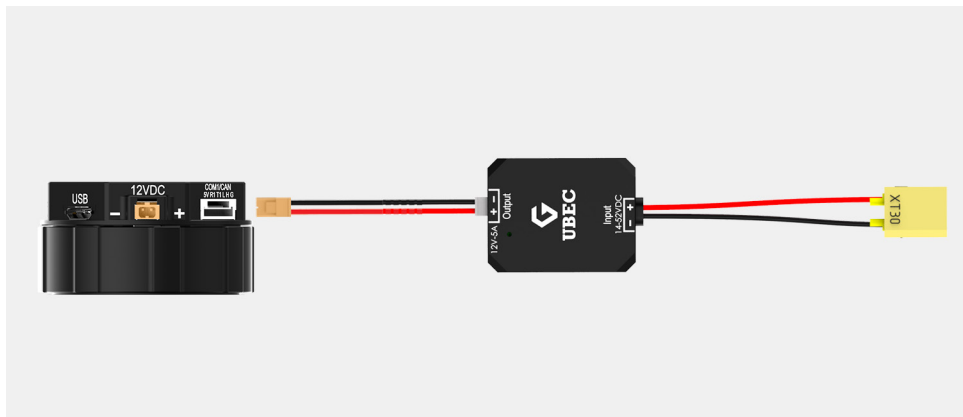

CONNECT

- **STEP 1:** The marks on the top part and bottom part must be aligned. The mark on the ring should be aligned with the unlocked icon as shown in the first picture.
- **STEP 2:** Keep everything aligned and attach the bottom part to the top part.
- **STEP 3:** Rotate the ring clockwise until the mark on the ring aligned with the locked icon.



DISCONNECT

- **STEP 1:** Rotate the ring counterclockwise.
- **STEP 2:** When the mark on the ring aligned with the unlock icon, the PIXY U can be detached from the top part of the Hyper Quick Release.



POWERING UP THE PIXY U

After connecting to the power supply, the gimbal will perform a series of alignments, self tests, which last about 2 seconds and the status of the gimbal will be indicated by the Status LED color. During this time, don't touch the gimbal or camera.

**NOTE**

If there is a remote-control signal, changing modes or turning motors on/off by other methods will not take effect because the remote-control signal has the highest priority and will override the command.

STEP 1

Make sure the Hyper Quick Release is mounted to the drone and its power port is already connected to the power supply correctly. Next, let's mount the gimbal to the Hyper Quick Release, it will be automatically powered up.

STEP 2

Wait about 2 seconds, do not touch the gimbal or camera.

STEP 3









If the status LED is blinking green, the gimbal is ready for use.

**NOTE**

If the status LED is solid red, something is wrong with the gimbal and motors can not start. Connect to the software/apps to check the details of the error message.

Read **“LED STATUS INDICATOR”** in next section for more information.

STATUS LED INDICATOR

STATE	LED STATUS	DESCRIPTION
01	 Blink	Low Battery
02	 Solid	System Error (Motor or IMU)
03	 Blink	Calibrating
04	 Solid	System Boot
05	 Blink	System Ready
06	 Blink	Lock Mode
07	 Solid	Follow Mode
08	 Blink	Remote with Lock Mode
09	 Solid	Remote with Follow Mode

OPERATION MODES

PIXY U HAS 2 OPERATION MODES

- **LOCK MODE:** is a stabilization mode where the camera maintains orientation independently of the rest of the gimbal and the orientation can be changed by an external control signal from remote control.
 - **FOLLOW MODE:** in this mode, the tilt and pan axis will follow movement of gimbal mounting platform such as drone or handlebar.
-

PIXY U SUPPORTS

- **SINGLE OPERATOR:** using FOLLOW mode.
- **DUAL OPERATOR:** a second operator can use a Remote Controller (SBUS, SPEKTRUM, PPM) to control gimbal's movement.

WORKING OPERATION

PIXY U has 2 working operations: Normal and Inverted.



After powering up the gimbal , it will automatically detect if the gimbal is in inverted operation or normal operation based on pan motor position.



NOTE

During working, switching to other working operation made easy by turning off motors and changing pan motor position, the gimbal will automatically detect new type of working operation after turning motors on again.

SWITCHING BETWEEN MODES

Using mode channel on remote control

POSITIONS	MODES
High	Follow Mode Motors ON
Middle	Lock Mode Motors ON
Low	Motors OFF

Using software

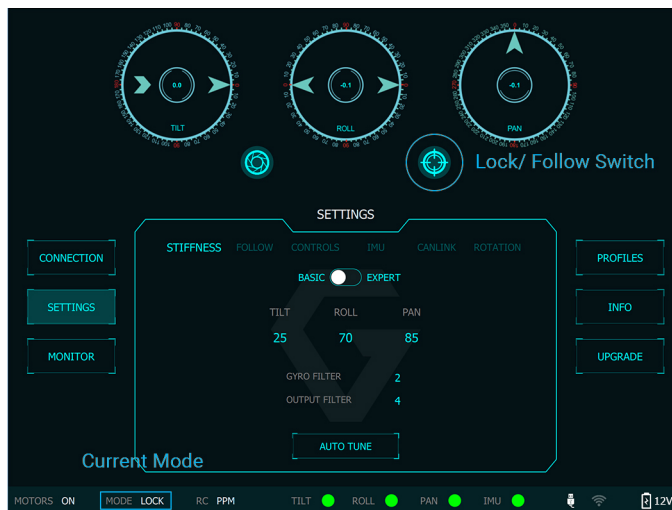

If there is a remote control signal, changing modes or turning motors on/off by other methods will not take effect because the remote control signal has the highest priority and override the command.

INSTALLING SOFTWARE

Desktop software

Download at:

www.gremesy.com -> [Support](#) -> [Product Support](#) -> [Pixy U](#)

■ USING USB CONNECTION



NOTE

Make sure the Silab USB driver is already installed. The driver can be found at:

www.gremesy.com -> [Support](#) -> [Product Support](#) -> [Pixy U](#)

STEPS TO CONNECT

- 1 - Power ON the PIXY U.
- 2 - Connect USB cable from gimbal controller to Mac/PC.
- 3 - Run the gTuneDesktop software.
- 4 - On Connection Tab, select the Serial option.
- 5 - Select the correct COM port in the list.
- 6 - Click on the "Connect" button.

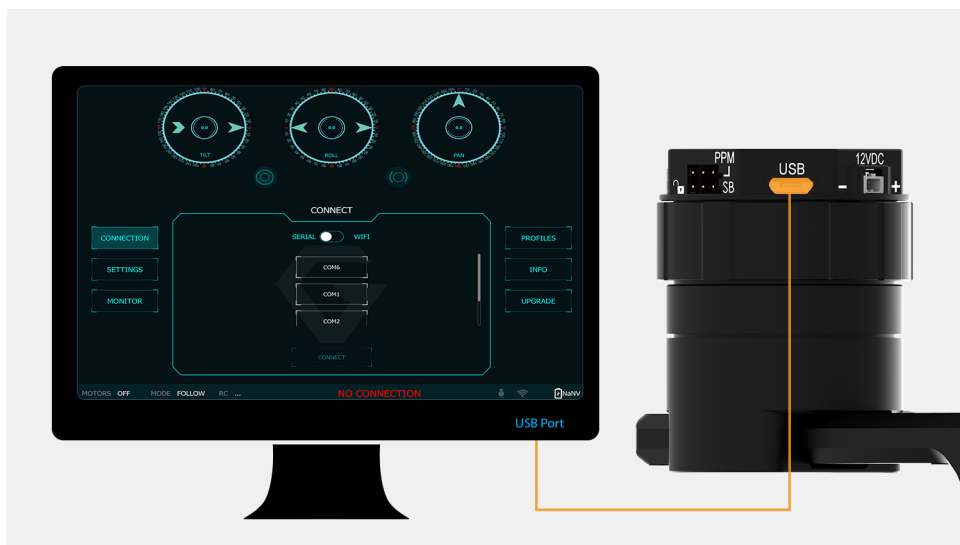

BALANCING

To achieve the best performance from the PIXY U, proper balancing is necessary. Accurate balance is critical in shots where the gimbal will be subjected to extreme movements or accelerations. There are 3 axes that need to be precisely balanced prior to powering up the gimbal.

MOUNTING THE CAMERA

Use a 1/4"-20 screw to secure the camera to the camera tray, then put the camera to the tilt cage



TILT AXIS FRONT-BACK BALANCE

When the proper front-back balance is achieved, the camera will stay level when you remove your hands.

1. Loosen the thumbscrew underneath the camera tray and the top bar knob. Then, gently slide the camera forward or backward until the tilt axis remains level.
2. Tighten the thumbscrew and knob to lock the camera and camera tray in position.



TILT AXIS VERTICAL BALANCE

When the proper vertical balance is achieved, you can rotate the camera in any angle and it will stay at that position.

1. Rotate the tilt axis so that the lens is pointing upward. Then, loosen the vertical adjustment thumbscrew, gently slide the camera mount crossbar forward and backward until the camera remains pointing upward when released.

2. Tighten the thumbscrew. Sometimes, the vertical balance could not be achieved, the front-back balance should be re-checked in this case.

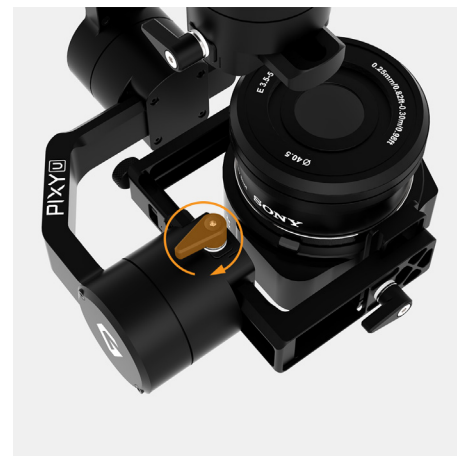
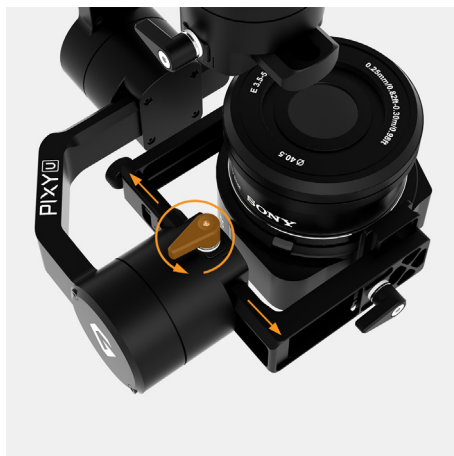

ROLL AXIS BALANCE

When the proper left-right roll balance is achieved, the camera will stay level when you remove your hands.

1. Loosen the thumbscrew underneath the roll bar, then gently slide the roll bar left or right until roll axis remains level.



2. Tighten the thumbscrew to lock the roll bar in position.



PAN AXIS BALANCE

Tilt the gimbal about 20 degrees from the verticality, identify if the gimbal is front heavy or back heavy. Slide the pan axis slider until the camera does not swing.

1. Loosen the thumbscrew, then gently slide the pan axis slider backward/forward until it doesn't swing and stay at any given position when released.

2. Tighten the thumbscrew to make sure pan axis slider is locked in position.

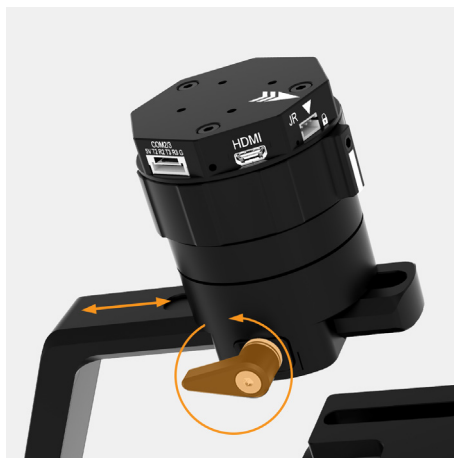

SOFTWARE - TUNING

After the camera is balanced on the Gremsy, it's time to fine tune some parameters for best performance.

STIFFNESS TUNING

Stiffness setting has a significant impact on the performance of the gimbal. This setting adjusts the degrees to which the gimbal tries to correct for unwanted camera movement and hold the camera stable. The higher you can run the setting without vibration or oscillation, the better.

GENERAL METHOD

Start with a low value of 20 for all axes then turn motors ON. Slowly increase this setting until you feel an oscillation in each axis, then reduce it until the oscillation subsides. You can touch the camera to feel the oscillation during tuning. Increase the stiffness setting 5-10 points at a time until oscillation appears then reduce 5 points until oscillation subsides.



STEP 01 - TILT STIFFNESS

Slowly increase this setting until you feel an oscillation in the tilt axis, then reduce the setting until the oscillation subsides. Make sure there is no vibration when tilting the camera up and down and when moving the gimbal in any orientation.

STEP 02 - ROLL STIFFNESS

Slowly increase this setting until you feel an oscillation in the roll axis, then reduce the setting until the oscillation subsides. Pick the gimbal up and make sure there is no vibration when you move the gimbal around.

STEP 03 - PAN STIFFNESS

Slowly increase this setting until you feel an oscillation in the pan axis, then reduce the setting until the oscillation subsides. Tilt the gimbal about 20 degrees from the verticality and make sure that no vibrations are presented.

FILTER

The purpose of the filters is to eliminate noise and vibration due to structural resonances in the camera, lens, or gimbal.

Setting the filters too high or too low can cause signal disturbances that can reduce the overall stabilization.

GYPRO FILTER

Defines the strength of the filter applied to Gyro sensor output. If the gimbal has oscillations that cannot be corrected by adjusting stiffness settings, the Gyro Filter is used to further tune the gimbal and remove the oscillation.

OUTPUT FILTER

Defines the strength of the filter applied to motor output. If the gimbal has oscillations that cannot be corrected by adjusting stiffness settings, the Output Filter is used to further tune the gimbal and remove the oscillation.

1. If the gimbal is vibrating at a high frequency after tuning, increase the filter values.
2. If the gimbal is oscillating or rocking at a low frequency after tuning, decrease the filter values.

GYRO FILTER

Gyro Filter	2
--------------------	---

Output Filter	3
----------------------	---

EXPERT / ADVANCED SETTINGS

There are some expert parameters that normally do not need to be adjusted. Leave these parameters at default settings unless they are required for troubleshooting.

HOLD STRENGTH

- If “Auto power adjustment” is enabled, “Hold strength” will be the minimum power level required for the corresponding axis. The controller will automatically adjust power level from minimum to maximum level depending on the displacement between the current angle and commanded angle.
- If “Auto power adjustment” is not selected “Hold strength” will be constant power level provided to the corresponding axis and should be adjusted manually. This option is only recommended for advanced users.



For heavy cameras, it's suggested to increase hold strength for each axis around 10% than the default value. If “Auto power adjustment” is not selected “Hold strength” will be fixed power level provided to the corresponding axis and should be adjusted manually. This option is only recommended for advanced users.

GAIN

Defines how fast each axis will return to commanded position. To reload default expert settings just press “Default” in the expert menu.

**DEFAULT SETTINGS**

	TILT	ROLL	PAN
HOLD STRENGTH	40	40	40
GAIN	120		
AUTO POWER ADJUSTMENT: ENABLED			

PREDEFINED PROFILES

For specific cameras, there is a list of predefined profiles that stores the suitable settings such as stiffness, gyro filter, output filter, hold strength, gain... accordingly. The predefined profile is made to best suit with specific camera and enable optimized performance without spending time tuning the gimbal.

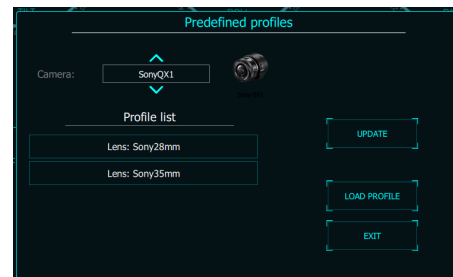
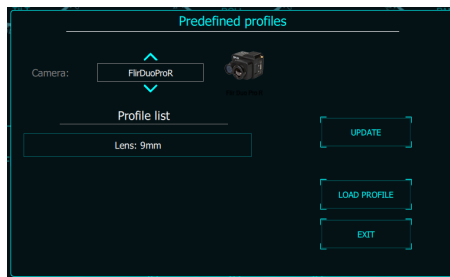
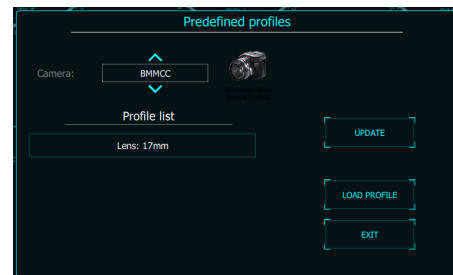
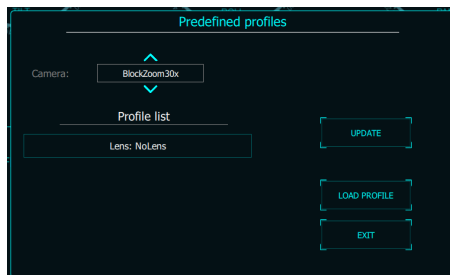

FOLLOW MODE SETTINGS

The most widely used mode of single operation is Follow mode where the gimbal operator controls to pan and tilt of the camera. The camera movement will mimic the user's input from the top-mount while the footage remains stable. The follow mode can be configured to be either very linear and robotic, or smooth and cinematic.

Follow mode settings is available for Tilt axis and Pan axis.

SPEED

Defines how fast camera will follow the movement.

SMOOTH

Smooth out the camera movement by adjusting this parameter. The higher the value is the smoother camera moves but at the expense of more delay in following the movements.

WINDOW

When the movement is out of the window zone, the camera starts to move. Within the window zone, the camera maintains its direction.

TILT LOCK

When the movement is out of the window zone, the camera starts to move. Within the window zone, the camera maintains its direction.

ROTATION LIMIT

If this option is selected, the tilt axis will maintain its angle and only be controlled by remote control.

UP LIMIT

Travel of Tilt and Roll axis can be limited using UP LIMIT and DOWN LIMIT. The Pan axis keeps the ability to pan 360 degrees itself.

DOWN LIMIT

Set the up limit for Tilt or Roll axis (in 1 degree unit). The default values are -90 for Tilt and -45 for Roll.

WINDOW

Set the down limit for Tilt or Roll axis (in 1 degree unit). The default values are 90 for Tilt and 45 for Roll.



IMU SENSOR

The IMU sensor used in the PIXY U is a combination of a high precision 3 axis gyroscope sensor and a 3 axis accelerometer sensor.

IMU board is being heated where the temperature inside is controlled around 50°C with 0.2°C accuracy. Thanks to this feature, gyro calibration is no longer required in most situations.

The PIXY U controller has a special algorithm to provide attitude estimation based on input data from the IMU sensor. This attitude estimation helps the controller to command motor output to compensate for camera movement.

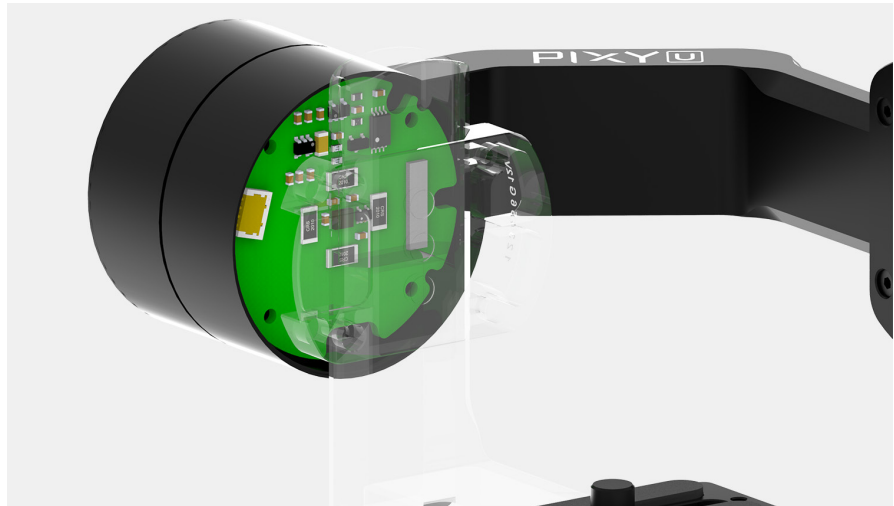

GYPRO CALIBRATION

Thanks to temperature controlled and heated IMU, gyro calibration is not necessary as the gyro was calibrated at the factory and the temperature inside IMU remains constant around 50 degrees. However, if you notice drift during operation in extreme weather (below -20C or above 50C) please re-calibrate the gyro.

- **CALIB AT STARTUP:** this feature is not available on the PIXY U



NOTE

After Gyro Calibration, Gyro Offset X, Y, Z will change to a new value depending on the temperature.



ACCELEROMETER CALIBRATION



Do not use this function, please contact Gremsy Support Engineers. Accelerometer sensor was calibrated properly at the factory to achieve accurate horizon level with special and precise equipment. Users do not need to do this unless it's required for troubleshooting.

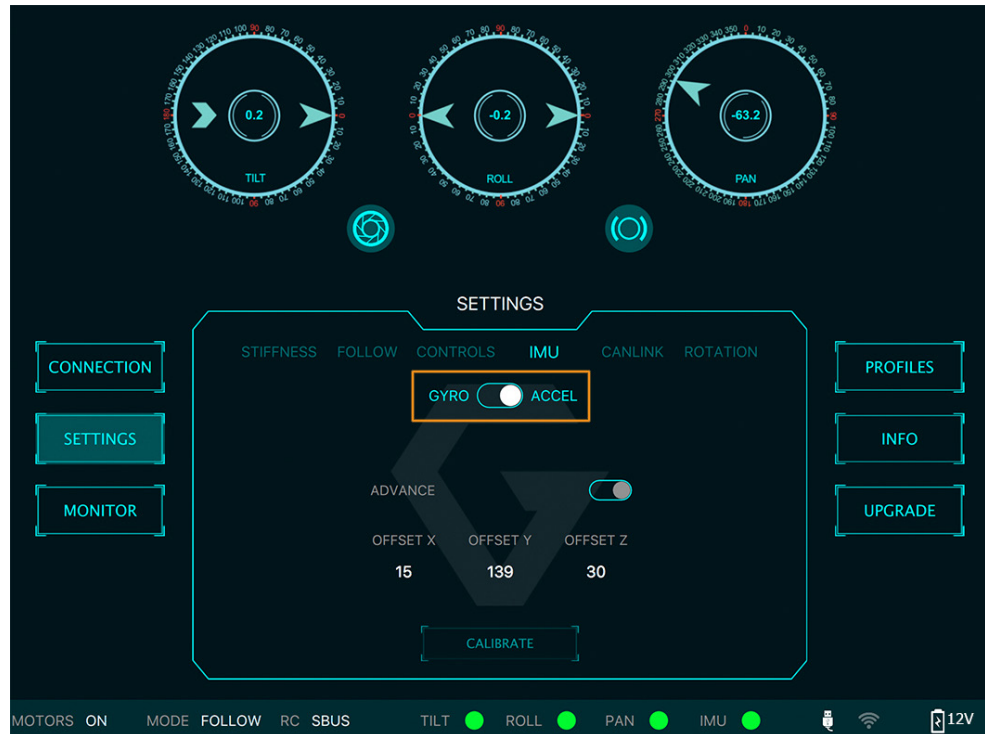

REMOTE CONTROL

PIXY U supports SBUS , SPEKTRUM and PPM receivers. There are some parameters to be aware of before assigning channels to the receiver.

- **SMOOTH:** increasing this number will smooth out the movement of the corresponding axis but will also cause a delay.
- **SPEED MODE:** when speed mode is selected, the speed of the corresponding axis will depend on how far the stick position is from the neutral position. It is recommended that TILT and PAN channels should be set to speed mode.
- **ANGLE MODE:** when angle mode is selected, the corresponding axis will move to the angle set by current stick/knob position. It's recommended ROLL channel should be set to angle mode.

SBUS/PPM SETTINGS

RECEIVER CONNECTION

Connect SBUS/PPM receiver to the SBUS/PPM port on the hyper quick release as shown in the picture.



The receiver must be connected to correct wires order. The SBUS/PPM port has 5V output to power the receiver, please do not use external power supply to power the receiver at the same time. Doing so may damage the electronic inside the gimbal.

There are 6 channels to assign: MODE, TILT, ROLL, PAN, TILT SPEED, PAN SPEED.

Assign MODE channel first then follow the order above because MODE channel is used to change operating modes of the gimbal and should be assigned to a 3-position switch as follows:

- **Switch at high position:** FOLLOW MODE , MOTORS ON
- **Switch at middle position:** LOCK MODE , MOTORS ON
- **Switch at low position:** MOTORS OFF

CHANNEL SETTING

TILT and PAN channel should be in speed mode and ROLL channel in angle mode.

TILT SPEED or PAN SPEED could be assigned to the same channel and should be assigned to throttle stick, dial, or other non-centering control on the transmitter.

Below is an example of channel assignment to the Futaba T8FG.

	CHANNEL	CONTROL	NOTE
MODE	5	SC	3 positions switch
TILT	2	J2	Speed mode
ROLL	4	T4	Angle mode
PAN	1	J1	Speed mode
TILT SPEED	4	J3	
PAN SPEED	6	RD	

JR/SPEKTRUM SETTINGS

JR/SPEKTRUM SATELLITE RECEIVER CONNECTION

Connect satellite receiver to the JR port on the hyper quick release as shown in the picture. Make sure satellite receiver is already bound to the transmitter (RED led is solid).

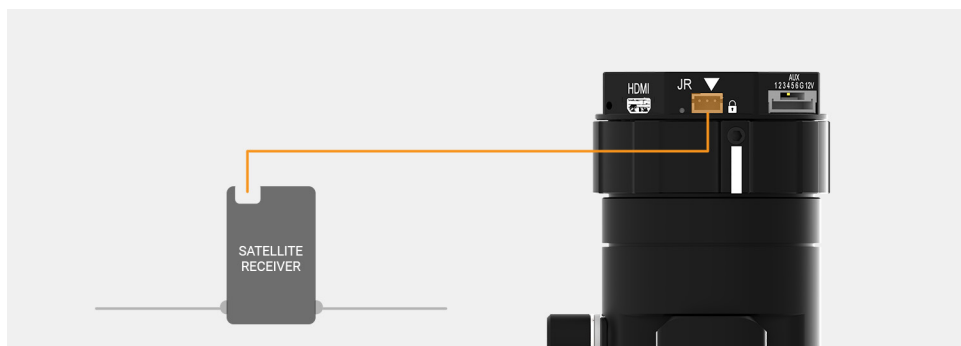

CHANNEL SETTING

Choose 10 bit or 11 bit type resolution on the software and assign proper channels as per SBUS settings.



UPGRADING FIRMWARE

Only USB connection allows upgrading firmware. Refer to Section "01. GETTING STARTED" for USB connection.



NOTE

Make sure Silab USB driver is already installed. The driver can be found at:

www.gremsy.com -> supports -> product support

HOW TO UPGRADE

- 01 - Power on the PIXY U.
- 02 - Connect USB cable from Pixy U to Mac/PC.
- 03 - Run the gTune Desktop software.
- 04 - In the software, select “Serial” option on “connection” tab.
- 05 - Select the port in the list.
- 06 - Click on the “Connect” button.
- 07 - Go to “Upgrade” tab.
- 08 - “Browse” to firmware file from your computer.
- 09 - Make sure the RF receiver (if available) is already removed.
- 10 - Click “Upgrade” button. The process will take about 2 minutes. When the firmware is upgraded successfully, the PIXY U will be restarted automatically.



TROUBLESHOOTING

Only USB connection allows upgrading firmware. Refer to Section "01. GETTING STARTED" for USB connection.



NOTE

Make sure Silab USB driver is already installed. The driver can be found at:

www.gremisy.com -> [supports](#) -> [product support](#) -> [Pixy U](#)

PROBLEM	POSSIBLE CAUSES	SOLUTION
Status LED is blinking red	Low battery	Recharge battery
Status LED is solid red during startup	Camera is not balanced well or not installed	Check camera balancing
	IMU cable is loose	Check in software for IMU sensor error, re-seat IMU sensor connector
	Tilt motor cable or encoder cable is loose	Check in software for Tilt error, re-seat tilt motor connector and encoder connector
	Roll motor cable or encoder cable is loose	Check in software for Roll error, re-connect roll motor connector and encoder cable
	Pan motor cable or encoder cable is loose	Check in software for Pan error, re-connect pan motor connector and encoder cable
Status LED is solid red during operation	IMU sensor cable is loose	Re-seat IMU sensor connector
Status LED is solid white after start up	Excessive gyro drift	Re-calibrate