



GREMSY



USER MANUAL

Version 3.0 | Feb 18th 2020

REVISION HISTORY

REVISION	DATE	DESCRIPTION
1.0	Feb 18 th 2020	User Manual

LEGEND



NOTE

Notes are used to highlight special operating conditions or steps of a procedure.



WARNING

Warnings are used to highlight procedures which, if not strictly observed, may result in personal injury or loss of life.



TIPS

Tips.

CONTENTS

Revision History	2
Legend	2
GETTING STARTED	6
Introduction	7
Features	8
HDMI Hyper Quick Release	
Plug & Play	
New I/O Design	
Heated & Temperature Controlled IMU	
High Performance Gimbal Controller	
Clean Design - Internal Wiring	
Built for Aerial Work	
Specifications	11
Gremsy T3 Mechanical Components	12
Gremsy T3 I/O Connectors	13
Hyper Quick Release Connectors & Pinouts	
Camera Tray Connector & Pinout	
What's In The Box	17
hdmi Hyper Quick Release	18
Mounting Hyper Quick Release	
Connect	
Disconnect	
Powering Up The Gremsy T3	20
Step 1	
Step 2	
Step 3	
Status LED Indicator	21

Operation Modes	22
Gremsy T3 Has 2 Operation Modes	
Gremsy T3 Supports	
Working Operation	
Swithching Between Modes	
Installing Software / App	26
Using USB/BLUETOOTH Connection	27
Using USB Connection	
Using BLUETOOTH Connection	
BALANCING	29
Mounting The Camera	30
Mounting The Hot Shoe Adapter	31
Tilt Axis Front-Back Balance	32
Tilt Axis Vertical Balance	33
Roll Axis Balance	34
Pan Axis Balance	35
SOFTWARE - TUNING	36
Stiffness Tuning	37
General Method	
Step 01 - Tilt Stiffness	
Step 02 - Roll Stiffness	
Step 03 - Pan Stiffness	
Filter	39
Gyro Filter	
Output Filter	
Default Values	

Expert / advanced settings	40
Hold Strength	
Gain	
Default Settings	
Follow Mode Settings	42
Speed	
Smooth	
Window	
Tilt Lock	
Airborne	
Rotation Limit	44
Up Limit	
Down Limit	
Roll Offset	
IMU Sensor	45
Gyro Calibration	
Accelerometer Calibration	
REMOTE CONTROL	48
SBUS/PPM Settings	49
Receiver Connection	
Channel Setting	
JR/SPEKTRUM Settings	51
JR / Spektrum Satellite Receiver Connection	
Channel Settings	
UPGRADING FIRMWARE	52
How To Upgrade	53
TROUBLESHOOTING	54

GETTING STARTED

INTRODUCTION

The new T3 features HDMI Quick Release as well as new I/O design and the ability to start up in 2 seconds. Moreover thanks to the increase in regulated voltage, motor power is also increased up to 20%

FEATURES

HDMI HYPER QUICK RELEASE

New mechanical and electrical integration quick release features floating connectors that allow to transmit high speed HDMI video signal while still maintain reliability after many mating cycles.



PLUG & PLAY

Say goodbye to complex setups and time consuming process. The T3 provides an easy one step plug and play installation that takes only 5 seconds to complete.



NEW I/O DESIGN

Intuitive hardware interface including a variety of ports has relocated on QR to quickly interface with multiple devices such as 3rd party flight controller, remote control, auxiliary I/O and power your ideal system of cameras/accessories.

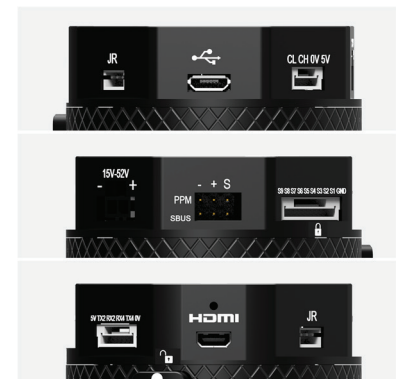

HEATED & TEMPERATURE CONTROLLED IMU

Heated and temperature controlled IMU sensor with advanced 6-point calibration allows reliable performance even in extreme weather. Temperature is maintained within 0.2 degrees Celsius accuracy.



HIGH PERFORMANCE GIMBAL CONTROLLER

gMotion Controller, designed and made by Gremsy based on a 32 bit high performance ARM microprocessor providing fast response and accurate calculation. Sensor data and motors correction are updated as fast as 2000 times per second to enable incredibly smooth footage.

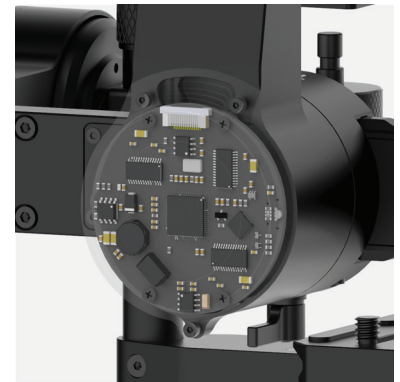

CLEAN DESIGN - INTERNAL WIRING

No exterior wires, more solid. This clean design helps the T3 overcome wind resistance with ease to bring out the best video quality while staying agile.



BUILT FOR AERIAL WORK

The T3 has a lot of nice features that enable users to apply it not only for aerial inspection and mapping but also for high end aerial cinematography.



SPECIFICATIONS

Product Name	Gremsy T3
System Type	3-Axis Digital Gyro-Stabilized
Weight	2.65 lbs / 1200 g
Camera Cage (Standard) (W X L X H)	152mm x 100mm x 120mm
Construction	All Aluminum
Input Voltage	15 – 52V
Working Current	Static Current 300mA @14.5V Dynamic Current 600mA @14.5V Locked Motor Current Max 4A @14.5V
Connection	USB, CAN, UART, BLUETOOTH
Payload	3.75lbs/1700g
OS Platform Supported	Windows / Mac / iOS / Android
Single Operator	Follow Mode / LB2
Dual Operator	SBUS / Spektrum / PPM / LB2
Pan Range	+/- 345 degree
Tilt Range	+/- 150 degree
Roll Range	+80/- 264 degree

GREMSY T3 MECHANICAL COMPONENTS



01. HDMI Hyper quick release

02. Pan motor

03. Pan adjustment

04. Roll motor

05. Gimbal controller

06. Roll adjustment

07. Tilt motor

08. Tilt top bar

09. Camera plate

10. Tilt front-back adjustment

11. Tilt vertical adjustment

12. Top camera screw

GREMSY T3 I/O CONNECTORS

HYPER QUICK RELEASE CONNECTORS & PINOUTS

■ **POWER:** to get power directly from external batteries of the drone or other power supply. Voltage input range from 15V to 52V and is down converted to a stable 14.5V by the internal circuit to provide power to gimbal and accessories.

Connector type: Molex Microfit 3.0 2 pin

■ **CAN:** to interface with CAN bus on DJI Flight controller or another module that uses CAN bus.

Connector type: JST SM04B-ZESS-TB

■ **COM2/COM4:** to interface with Pixhawk or Pixhawk 2 via Mavlink protocol or other modules that use serial protocol (UART).

Connector type: JST SM06B-ZESS-TB

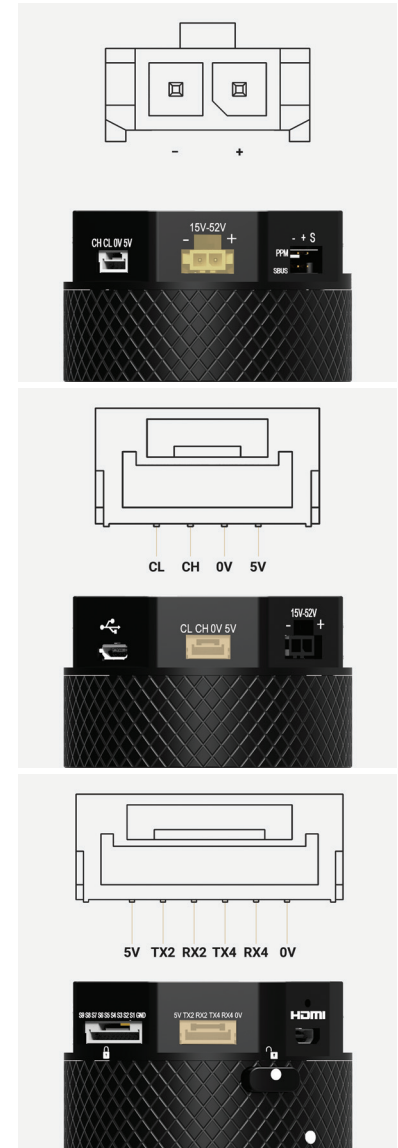

■ **SBUS/PPM:** To interface with SBUS/PPM receiver.

■ **AUX:** There are S1, S2, S3,...,S8,S9 optional signal (0.25A max) for users to connect to other devices such as AV signal or camera trigger...This port is internally connected to AUX port on the camera tray.

Connector type: JST SM10B-GHS-TB

■ **USB:** to interface with computer or upgrading firmware

Connector type: Micro USB TYPE B

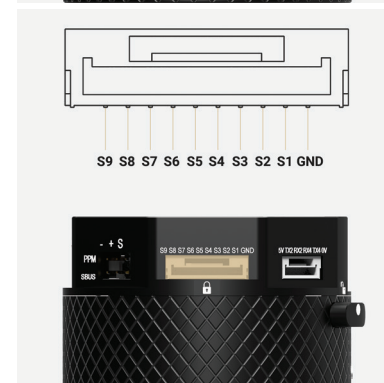
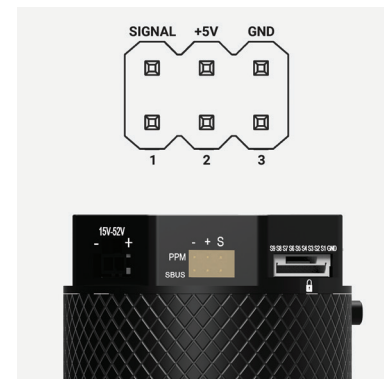

■ **JR:** to interface with JR/SPEKTRUM satellite receiver.

Connector type: JST S3B-ZR

■ **HDMI:** HDMI video output from the camera.

Connector type: Micro HDMI

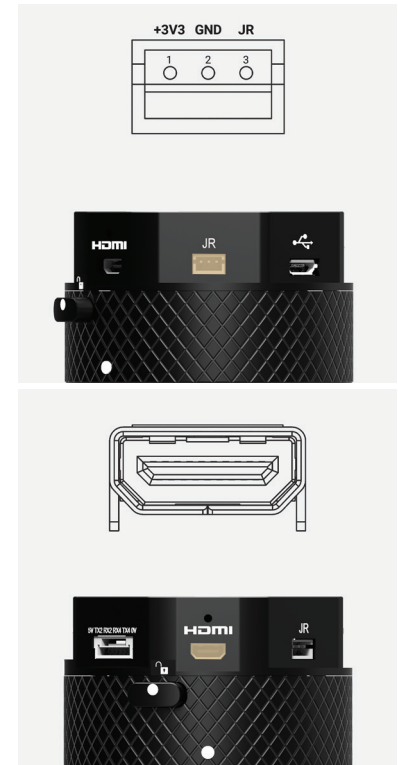

CAMERA TRAY CONNECTOR & PINOUT

■ **AUX:** There are S1, S2, S3,...,S8,S9 optional signal (0.25A max) for users to connect to other devices such as AV signal or camera trigger...This port is internally connected to AUX port on the Hyper Quick Release.

Connector type: JST SM10B-ZESS-TB

■ **PWT OUT:** 14.5V 2A output for camera and accessories.

Connector type: JST S2B-XH-A(LF)

■ **HDMI:** HDMI video input from the camera.

Connector type: Micro HDMI

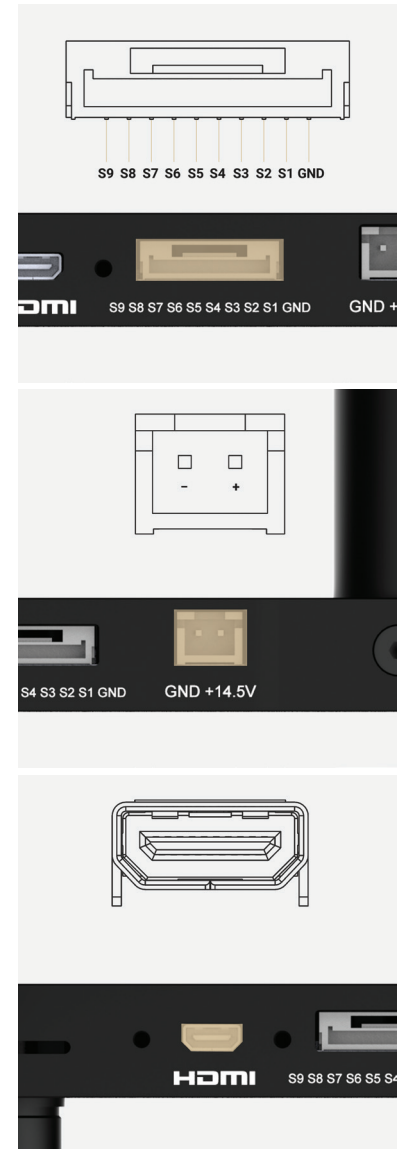

WHAT'S IN THE BOX

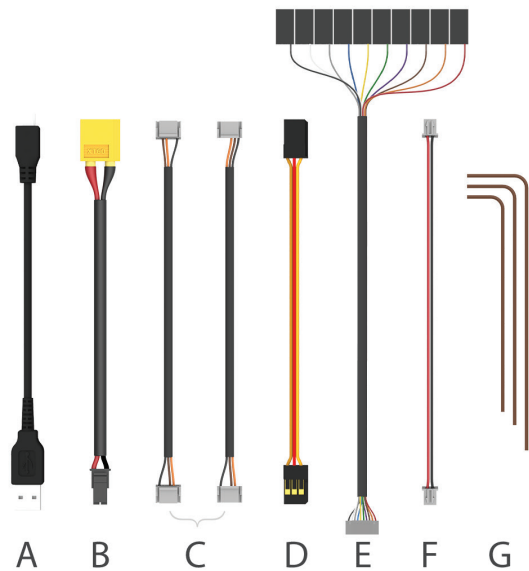
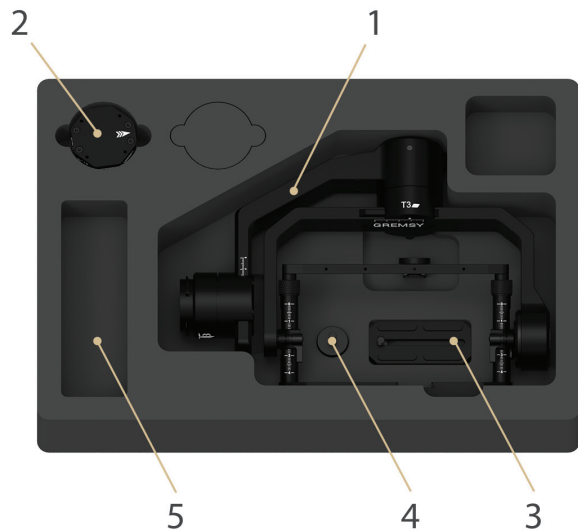

01. GREMSY T3 GIMBAL

03. SLIDE CAMERA & CAMERA SCREW

05. GREMSY T3 CABLES & TOOLS

A. Micro USB Cable	x1
B. Power Supply Cable	x1
C. Canlink Cable For Pixhawk (COM2/COM4)	x1
D. Sbus Cable	x1

02. HDMI HYPER QUICK RELEASE

04. HOTSHOE EXTENSION

E. Auxiliary Cable	x2
F. PWT Cable	x1
G. Allen Key Set	x1

HDMI HYPER QUICK RELEASE

MOUNTING HYPER QUICK RELEASE

Using 32mm square M3 pattern to mount the top part onto the frame or damping isolator.



CONNECT

- **STEP 1:** The marks on the top part and bottom part must be aligned. The button on the ring should be aligned with the unlocked icon as shown in the first picture.
- **STEP 2:** Keep everything aligned and attach the bottom part to the top part.
- **STEP 3:** Rotate the ring clockwise until hearing a snap, the button should be automatically popped out and aligned with a locked icon.



DISCONNECT



- **STEP 1:** Press and hold the button.
- **STEP 2:** Rotate the ring counterclockwise.
- **STEP 3:** When the button aligns the unlock icon, the T3 can be detached from the top part of Hyper Quick Release.



POWERING UP THE GREMSY T3

After connecting to the power supply, the gimbal will perform a series of alignments, self tests, which last about 2 seconds and will determine the status of the gimbal, indicated by the Status LED color. During this time, don't touch the gimbal or camera.



NOTE

Always start the gimbal with a balanced camera set up otherwise after initialization the controller will return an error followed by a red color indicator.

STEP 1

Make sure the Hyper Quick Release is mounted to the drone and its power port is already connected to the power supply correctly. Next, let's mount the gimbal to the Hyper Quick Release, it will be automatically powered up.

STEP 2

Wait about 2 seconds, do not touch the gimbal or camera.

STEP 3

If the status LED is blinking green, the gimbal is ready for use. By default, the gimbal is in Follow mode if the motors are turned ON by the Function Button.















NOTE

If the status LED is solid red, something is wrong with the gimbal and motors can not start. Connect to the software/apps to check details of the error message.

Read "**LED STATUS INDICATOR**" in next section for more information.



STATUS LED INDICATOR

STATE	LED STATUS	DESCRIPTION
01	 Blink	Low Battery
02	 Solid	System Error (Motor or IMU)
03	 Blink	Calibrating
04	 Solid	System Boot
05	 Blink	System Ready
06	 Blink	Lock Mode
07	 Solid	Follow Mode
08	 Blink	Remote with Lock Mode
09	 Solid	Remote with Follow Mode
10	 Blink	Auto-tuning in process
11	 Blink	Canlink with Lock Mode
12	 Solid	Canlink with Follow Mode



OPERATION MODES

GREMSY T3 HAS 2 OPERATION MODES

■ **LOCK MODE:** is a stabilization mode where the camera maintains orientation independently of the rest of the gimbal and the orientation can be changed by an external control signal from remote control.

■ **FOLLOW MODE:** in this mode, the camera will mimic the operator's movement and allows one person to control camera tilt and pan without using an external device like a remote control.

GREMSY T3 SUPPORTS

■ **SINGLE OPERATOR:** using FOLLOW mode.

■ **DUAL OPERATOR:** a second operator can use a Remote Controller (SBUS, SPEKTRUM, PPM) to control gimbal's movement.

WORKING OPERATION

Gremsy T3 has 2 working operations: Normal and Inverted.



After powering up the gimbal , it will automatically detect if the gimbal is in inverted operation or normal operation based on pan motor position.



TIPS

During working, switching to another working operation made easy by changing pan motor position, the gimbal will automatically detect new types of working operation.

SWITCHING BETWEEN MODES ■ **Using function button**

PRESS TIMES	MODES
Once time	Turn motors ON
2 times	Lock mode
3 times	Follow mode
Hold 3 seconds	Turn motor OFF

■ **Using mode channel on remote control**

POSITIONS	MODES
High	Follow mode Motors ON
Midle	Lock mode Motors ON
Low	Motors OFF

■ Using software/application

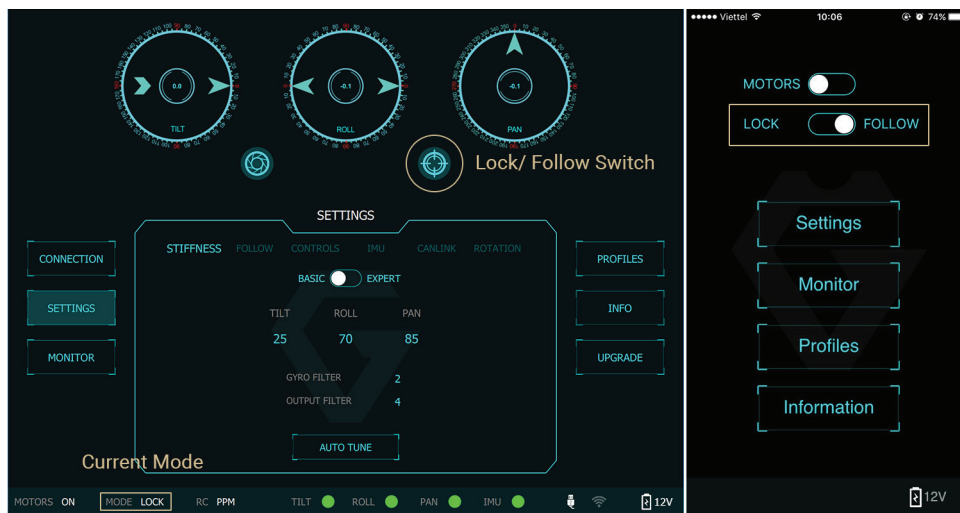

NOTE

NOTE: If there is a remote control signal, changing modes or turning motors on/off by other methods such as using the function button or software will not take effect because the remote control signal has the highest priority and override the command.

INSTALLING SOFTWARE / APP

Mobile apps are available in App Store and Google Play

App name: gTune

Searching: "gremsy gtune"

Desktop software

Download at:

www.gremsy.com -> Support -> Product Support -> Gremsy T3



USING USB/ BLUETOOTH CONNECTION

USING USB CONNECTION

To configure and monitor data of Gremsy software/app either USB/Wi-fi connection is required.



NOTE

Make sure the Silab USB driver is already installed. The driver can be found at:

www.gremsy.com -> Support -> Product Support

■ STEPS TO CONNECT:

- 1 - Power ON the T3.
- 2 - Connect USB cable from gimbal controller to Mac/PC.
- 3 - Run the gTuneDesktop software.
- 4 - On Connection Tab, select the Serial option.
- 5 - Select the correct COM port in the list.
- 6 - Click on the “Connect” button.



USING BLUETOOTH CONNECTION

■ ON MOBILE APP

STEPS TO CONNECT:

1 - Enable bluetooth adapter of mobile devices

On Android: the OS will ask for Location Data permission for BLE scanning feature (updated by Google since Android 6.0)

On iOS: the OS will sometimes have issues with its Bluetooth adapter. Users should check the device's quick settings and general settings to enable the adapter and the Bluetooth icon should appear on the device's status bar.

2 - Turn ON the gimbal and run the app.

After switching to Bluetooth, the app will begin scanning for Gremisy Bluetooth integrated gimbals.

If only one gimbal is found, it will be connected automatically.

If more than one gimbal is found, a list of gimbals will be shown to allow the user to select the desired one.

If no gimbal is found, an error will be shown.

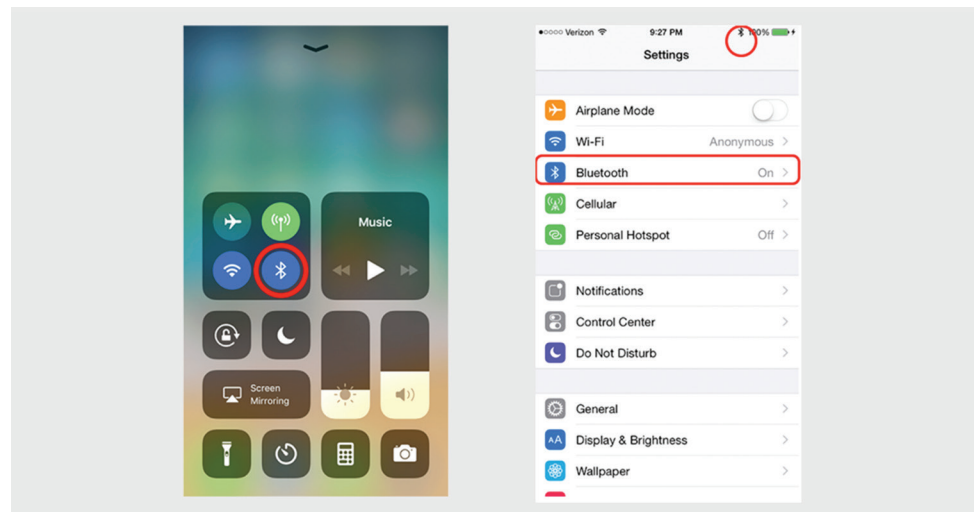

BALANCING

To achieve the best performance from the T3, proper balancing is necessary. Accurate balance is critical in shots where the gimbal will be subjected to extreme movements or accelerations. There are 3 axes that need to be precisely balanced prior to powering up the gimbal.

MOUNTING THE CAMERA

Use a 1/4"-20 screw to secure the camera to the camera tray, then put the camera to the gimbal and tighten the top bar screw.



MOUNTING THE HOT SHOE ADAPTER

Use a provided hotshoe adapter to mount it onto hotshoe of the camera



NOTE

For short cameras like Sony A6000/A6300 , hot shoe extension block should be used to increase the height

TILT AXIS FRONT-BACK BALANCE

When the proper front-back balance is achieved, the camera will stay level when you remove your hands.



1. Loosen the thumbscrew underneath the camera tray and the top bar screw. Then, gently slide the camera forward or backward until the tilt axis remains level.

2. Tighten the thumbscrews to lock the camera and camera tray in position.

TILT AXIS VERTICAL BALANCE

When the proper vertical balance is achieved, you can rotate the camera in any angle and it will stay at that position.



1. Rotate the tilt axis so that the lens is pointing upward. Then, loosen both vertical adjustment thumbscrews, gently slide the camera mount crossbar and the top bar forward and backward until the camera remains pointing upward when released.

2. Tighten the thumbscrews. Check the number markings on both vertical rods are the same. Sometimes, the vertical balance could not be achieved, the front-back balance should be re-checked in this case.

ROLL AXIS BALANCE

When the proper left-right roll balance is achieved, the camera will stay level when you remove your hands.



1. Loosen the thumbscrew underneath the roll bar, then gently slide the roll bar left or right until roll axis remains level.
2. Tighten the thumbscrew to lock the roll bar in position.

PAN AXIS BALANCE

Tilt the gimbal about 20 degrees from the verticality, identify if the gimbal is front heavy or back heavy. Slide the pan axis slider until the camera does not swing.

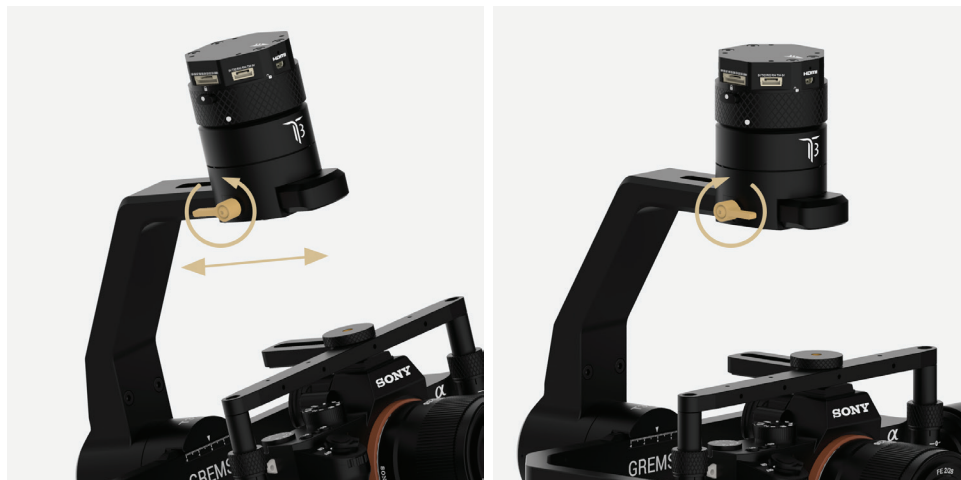

1. Loosen the thumbscrew, then gently slide the pan axis slider backward/ forward until it doesn't swing and stay at any given position when released.
2. Tighten the thumbscrew to make sure pan axis slider is locked in position.

SOFTWARE - TUNING

After the camera is balanced on the Gremsy, it's time to fine tune some parameters for best performance.

STIFFNESS TUNING

Stiffness setting has a significant impact on the performance of the T3. This setting adjusts the degrees to which the gimbal tries to correct for unwanted camera movement and hold the camera stable. The higher you can run the setting without vibration or oscillation, the better.

GENERAL METHOD

Start with a low value of 20 for all axes then turn motors ON. Slowly increase this setting until you feel an oscillation in each axis, then reduce it until the oscillation subsides. You can touch the camera to feel the oscillation during tuning. Increase the stiffness setting 5-10 points at a time until oscillation appears then reduce 5 points until oscillation subsides.



STEP 01 - TILT STIFFNESS

Slowly increase this setting until you feel an oscillation in the tilt axis, then reduce the setting until the oscillation subsides. Make sure there is no vibration when tilting the camera up and down and when moving the gimbal in any orientation.

STEP 02 - ROLL STIFFNESS

Slowly increase this setting until you feel an oscillation in the roll axis, then reduce the setting until the oscillation subsides. Pick the T3 up and make sure there is no vibration when you move the gimbal around.

STEP 03 - PAN STIFFNESS

Slowly increase this setting until you feel an oscillation in the pan axis, then reduce the setting until the oscillation subsides. Tilt the T3 about 20 degrees from the verticality and make sure that no vibrations are presented.

FILTER

The purpose of the filters is to eliminate noise and vibration due to structural resonances in the camera, lens, or gimbal.

Setting the filters too high or too low can cause signal disturbances that can reduce the overall stabilization.

GYRO FILTER

Defines the strength of the filter applied to Gyro sensor output. If the gimbal has oscillations that cannot be corrected by adjusting stiffness settings, the Gyro Filter is used to further tune the gimbal and remove the oscillation.

OUTPUT FILTER

Defines the strength of the filter applied to motors output. If the gimbal has oscillations that cannot be corrected by adjusting stiffness settings, the Output Filter is used to further tune the gimbal and remove the oscillation.

1. If the gimbal is vibrating at a high frequency after tuning, increase the filter values.

2. If the gimbal is oscillating or rocking at a low frequency after tuning, decrease the filter values.

DEFAULT VALUES

Gyro Filter	2
--------------------	---

Output Filter	3
----------------------	---

EXPERT / ADVANCED SETTINGS

There are some expert parameters that normally do not need to be adjusted. Leave these parameters at default settings unless they are required for troubleshooting.

HOLD STRENGTH

If “Auto power adjustment” is enabled, “Hold strength” will be the minimum power level required for the corresponding axis. The controller will automatically adjust power level from minimum to maximum level depending on the displacement between current angle and commanded angle.

If “Auto power adjustment” is not selected “Hold strength” will be constant power level provided to the corresponding axis and should be adjusted manually. This option is only recommended for advanced users.



NOTE

For heavy cameras, it's suggested to increase hold strength for each axis around 10% than the default value. If “Auto power adjustment” is not selected “Hold strength” will be fixed power level provided to the corresponding axis and should be adjusted manually. This option is only recommended for advanced users.

GAIN

Defines how fast each axis will return to commanded position. To reload default expert settings just press “Default” in the expert menu.

**DEFAULT SETTINGS**

	TILT	ROLL	PAN
HOLD STRENGTH	40	40	40
GAIN	120		
AUTO POWER ADJUSTMENT: ENABLED			



FOLLOW MODE SETTINGS

The most widely used mode of single operation is Follow mode where the gimbal operator controls to pan and tilt of the camera. The camera movement will mimic the user's input from the top-mount while the footage remains stable. The follow mode can be configured to be either very linear and robotic, or smooth and cinematic.

Follow mode settings is available for Tilt axis and Pan axis.

SPEED

Defines how fast camera will follow the movement.

SMOOTH

Smooth out the camera movement by adjusting this parameter. The higher the value is the smoother camera moves but at the expense of more delay in following the movements.

WINDOW

When the movement is out of the window zone, the camera starts to move. Within the window zone, the camera maintains its direction.

TILT LOCK

If this option is selected, the tilt axis will maintain its angle and only be controlled by remote control.

AIRBORNE

This feature is not available on the T3.



ROTATION LIMIT

Travel of Tilt and Roll axis can be limited using UP LIMIT and DOWN LIMIT. The Pan axis keeps the ability to pan 360 degrees itself.



UP LIMIT

Set the up limit for Tilt or Roll axis (in 1 degree unit). The default values are -90 for Tilt and -45 for Roll.

DOWN LIMIT

Set the down limit for Tilt or Roll axis (in 1 degree unit). The default values are 90 for Tilt and 45 for Roll.

ROLL OFFSET

Set the Roll offset (in 0.1 degree unit) is only applicable when there is no remote control signal since remote control will override the roll angle. This is useful to fine trim the horizon. The default value is 0.

IMU SENSOR

The IMU sensor used in the T3 is a combination of a high precision 3 axis gyroscope sensor and a 3 axis accelerometer sensor.

IMU board is enclosed in a weather proof case and being heated where the temperature inside is controlled around 50°C with 0.2°C accuracy. Thanks to this feature, gyro calibration is no longer required in most situations.

In order to provide extra high precision data output, the IMU is performed 6-point calibration at Gremsy factory.

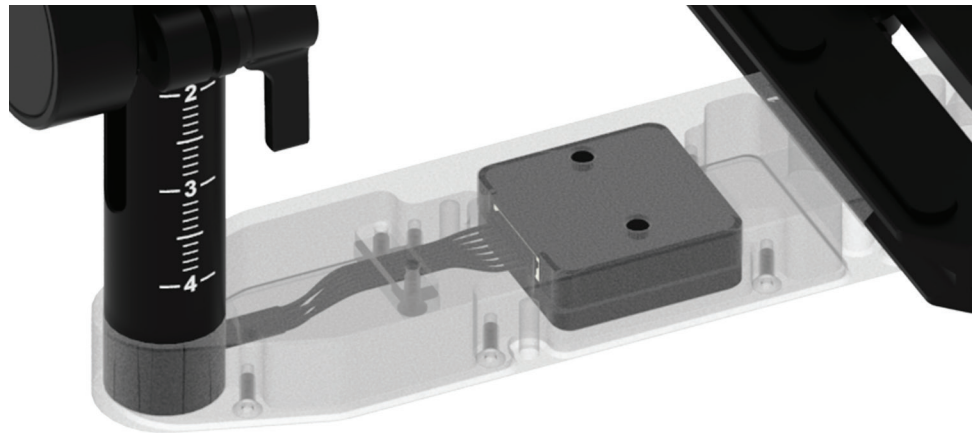

The T3 controller has a special algorithm to provide attitude estimation based on input data from the IMU sensor. This attitude estimation helps the controller to command motor output to compensate for camera movement.

GYRO CALIBRATION

Thanks to temperature controlled and heated IMU, gyro calibration is not necessary as the gyro was calibrated at the factory and the temperature inside IMU remains constant around 50 degrees. However, if you notice drift during operation in extreme weather (below -20C or above 50C) please re-calibrate the gyro.

- **CALIB AT STARTUP:** this feature is not necessary on the T3



NOTE

After Gyro Calibration, Gyro Offset X, Y, Z will change to a new value depending on the temperature.



ACCELEROMETER CALIBRATION



Do not use this function, please contact Gremsy Support Engineers. Accelerometer sensor was calibrated properly at the factory to achieve an accurate horizon level with special and precise equipment. Users do not need to do this unless it's required for troubleshooting.



REMOTE CONTROL

T3 supports SBUS , SPEKTRUM and PPM receivers. There are some parameters to be aware of before assigning channels to the receiver.

- **SMOOTH:** increasing this number will smooth out the movement of the corresponding axis but will also cause a delay.

- **SPEED MODE:** when speed mode is selected, the speed of the corresponding axis will depend on how far the stick position is from the neutral position. It is recommended that TILT and PAN channels should be set to speed mode.

- **ANGLE MODE:** when angle mode is selected, the corresponding axis will move to the angle set by current stick/knob position. It's recommended ROLL channel should be set to angle mode.

SBUS/PPM SETTINGS

RECEIVER CONNECTION

Connect SBUS/PPM receiver to the Hyper Quick release as shown below

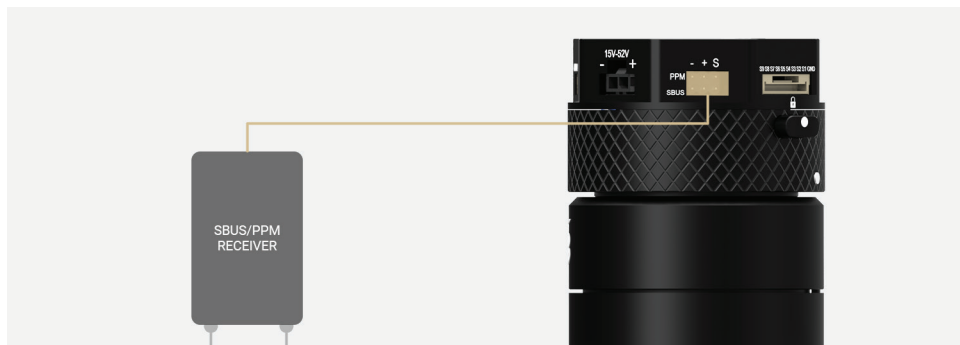

WARNING

The receiver must be connected to correct wires. The SBUS/PPM port has 5V output to power the receiver, please do not use external power supply to power the receiver at the same time. Doing so may damage the electronics inside the gimbal.

CHANNEL SETTING

There are 6 channels to assign: MODE, TILT, ROLL, PAN, TILT SPEED, PAN SPEED

Assign MODE channel first then follow the order above because MODE channel is used to change operating modes of the gimbal and should be assigned to a 3-position switch as follows:

- **Switch at high position:** FOLLOW MODE , MOTORS ON
- **Switch at middle position:** LOCK MODE , MOTORS ON
- **Switch at low position:** MOTORS OFF

TILT and PAN channel should be in speed mode and ROLL channel in angle mode.

TILT SPEED or PAN SPEED could be assigned to the same channel and should be assigned to throttle stick, dial, or other non-centering control on the transmitter.

Below is an example of channel assignment to the Futaba T8FG.

	CHANNEL	CONTROL	NOTE
MODE	5	SC	3 positions switch
TILT	2	J2	Speed mode
ROLL	4	T4	Angle mode
PAN	1	J1	Speed mode
TILT SPEED	3	J3	
PAN SPEED	6	RD	

JR/SPEKTRUM SETTINGS

JR / SPEKTRUM SATELLITE RECEIVER CONNECTION

Connect satellite receiver to the JR port on the Hyper quick release as shown in the picture. Make sure satellite receiver is already bound to the transmitter (RED led is solid).

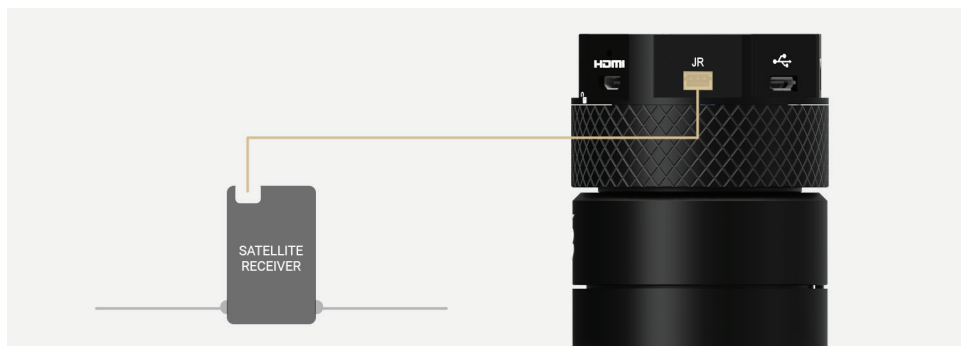

CHANNEL SETTINGS

Choose 10 bit or 11 bit type resolution on the software and assign proper channels as per SBUS settings.



UPGRADING FIRMWARE

Only USB connection allows upgrading firmware. Refer to Section "01. GETTING STARTED" for USB connection.



Make sure Silab USB driver is already installed. The driver can be found at:

www.gremsy.com -> [supports](#) -> [product support](#)

HOW TO UPGRADE

- 01 - Power on the T3.
- 02 - Connect USB cable from T3 controller to Mac/PC.
- 03 - Run the gTune Desktop software.
- 04 - In the software, select “Serial” option on “connection” tab.
- 05 - Select the port in the list.
- 06 - Click on the “Connect” button.
- 07 - Go to “Upgrade” tab.
- 08 - “Browse” to firmware file from your computer.
- 09 - Make sure the RF receiver (if available) is already removed.
- 10 - Click “Upgrade” button. The process will take about 2 minutes. When the firmware is upgraded successfully, the T3 will be restarted automatically.



TROUBLESHOOTING

PROBLEM	POSSIBLE CAUSES	SOLUTION
Status LED is blinking red	Low battery	Recharge battery
Status LED is solid red during startup	Camera is not balanced well or not installed	Check camera balancing
	IMU cable is loose	Check in software for IMU sensor error, re-seat IMU sensor connector
	Tilt motor cable or encoder cable is loose	Check in software for Tilt error, re-seat tilt motor connector and encoder connector
	Roll motor cable or encoder cable is loose	Check in software for Roll error, re-connect roll motor connector and encoder cable
Status LED is solid red during operation	Pan motor cable or encoder cable is loose	Check in software for Pan error, re-connect pan motor connector and encoder cable
	IMU sensor cable is loose	Re-seat IMU sensor connector
Status LED is solid white after start up	Excessive gyro drift	Re-calibrate
Gremsy T3 has oscillation in one or more axes	Stiffness setting is too high	Reduce stiffness
	Thumbscrew/top bar nut is not tightened	Check tightening
	Camera mounting is not stiff enough	Check camera mounting
	Filters settings are incorrect: Gyro and output filter should only be changed if other methods of reducing oscillation have failed	Please read more in manual about Gyro filter and output filter (Advanced settings)

Gremsy gimbal seems to be drifting	Gyro sensor is drifting too much	Re-calibrate gyro
Motors seem to be weak	Stiffness is too low	Increase stiffness
	Auto-power adjustment is not enabled	Check in Expert menu if Auto-power adjustment is enabled or not
Footage appears to wobble side to side or up and down	Camera is not properly balanced	Check camera balance
	Stiffness setting is low	Increase stiffness settings, start with the axis which is poorly stabilized. Higher Stiffness will achieve better stabilization. The tuning process is described in the user manual.